

TOP VIEW

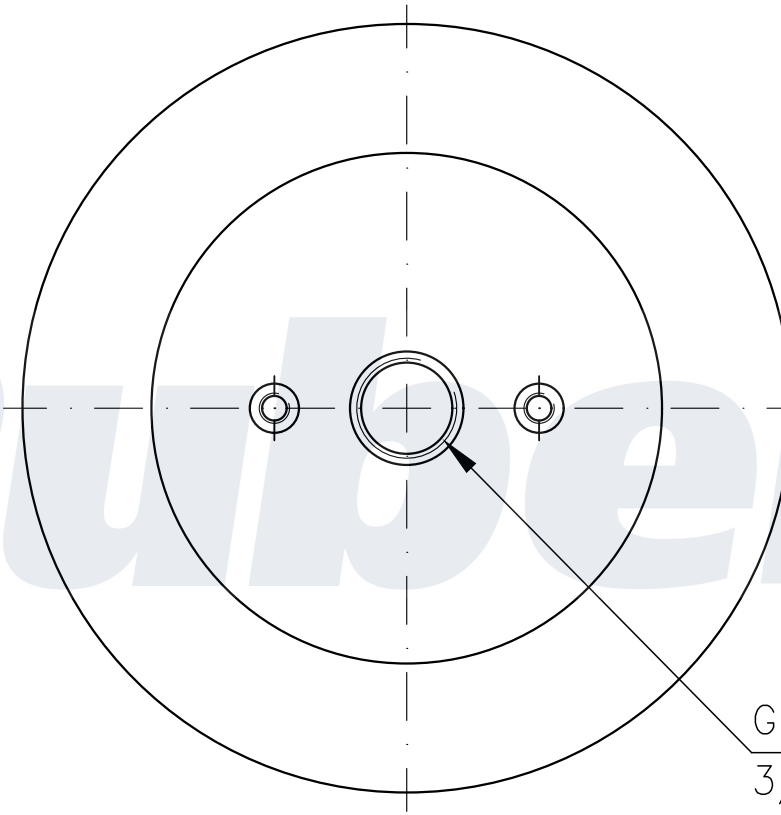

BOTTOM VIEW

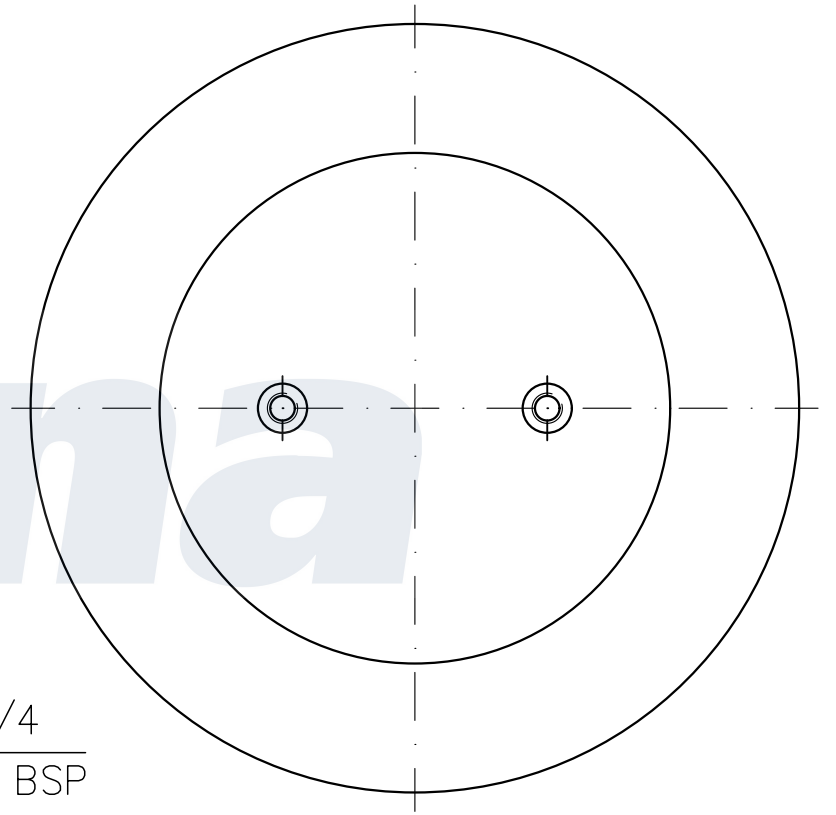

G 3/4
 3/4 BSP
 AIR INLET