

TOP VIEW

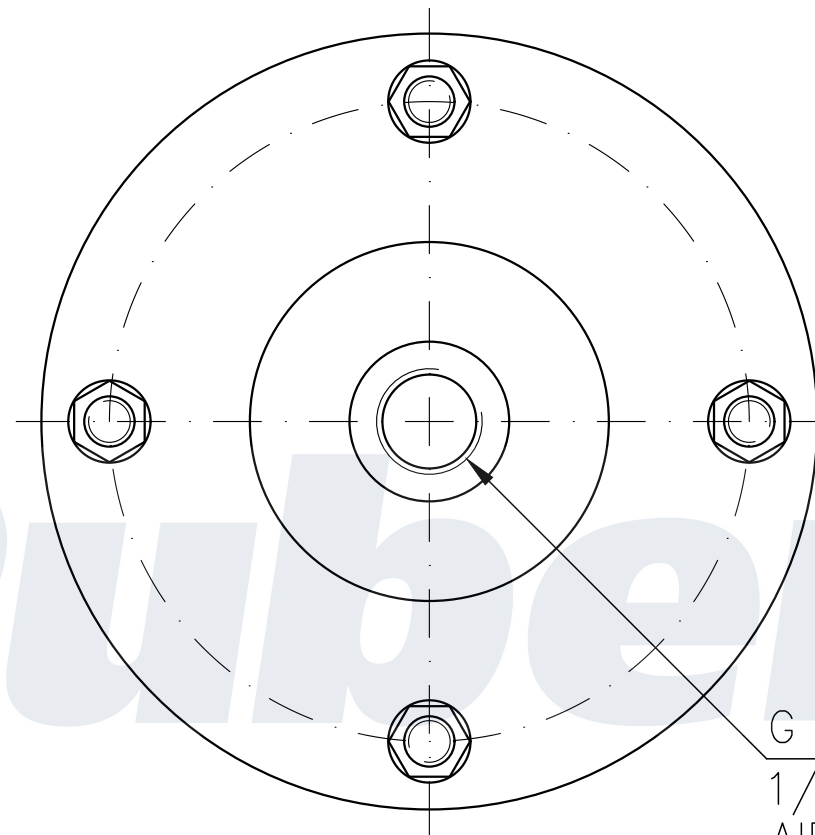

BOTTOM VIEW

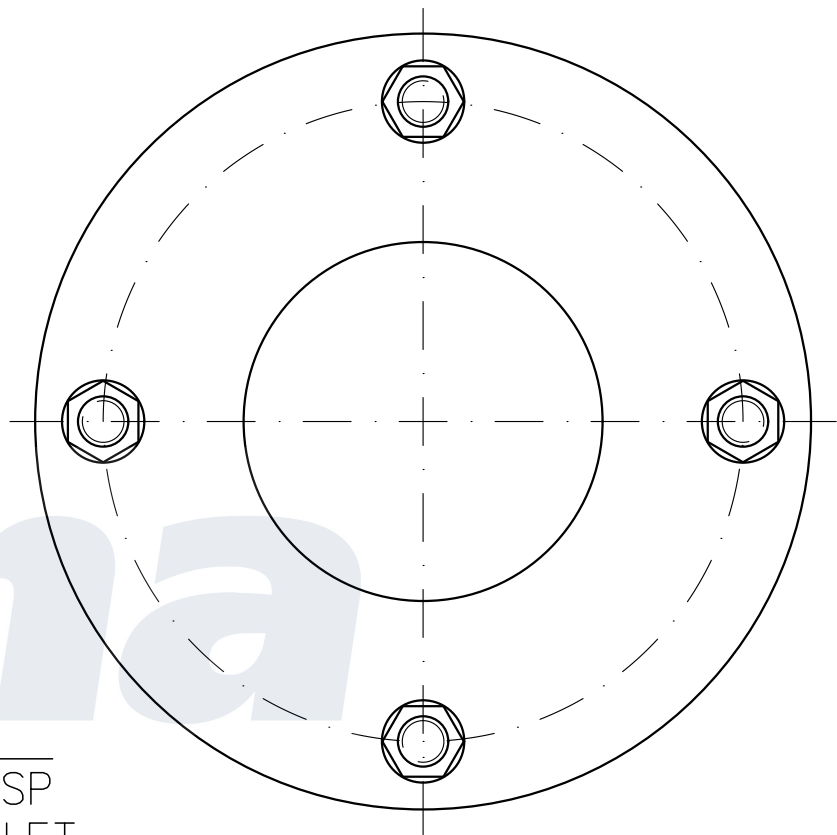

G 1/2
 1/2 BSP
 AIR INLET