

TOP VIEW

BOTTOM VIEW

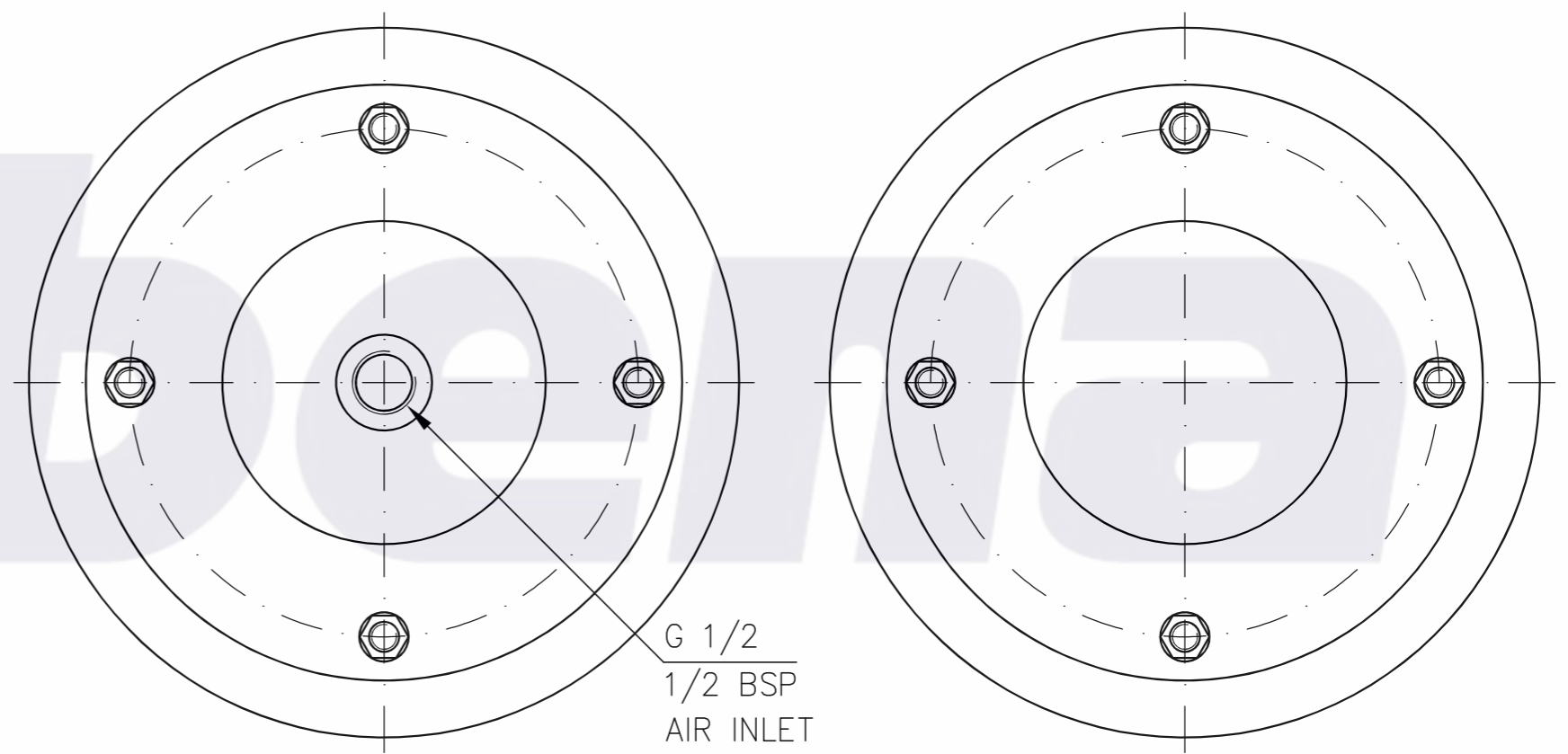

Dunlop design line - 9 1/4" x 2